



Rodovia SC-492 - Km 10 - B. Industrial
89905-000 - Bandeirante - SC
Fone: (49) 3622-4549
e-mail: mxmoveis@mxmoveis.com.br



Ref. CO008

Cômoda Oslo
Cómoda Oslo
Oslo chest of drawers

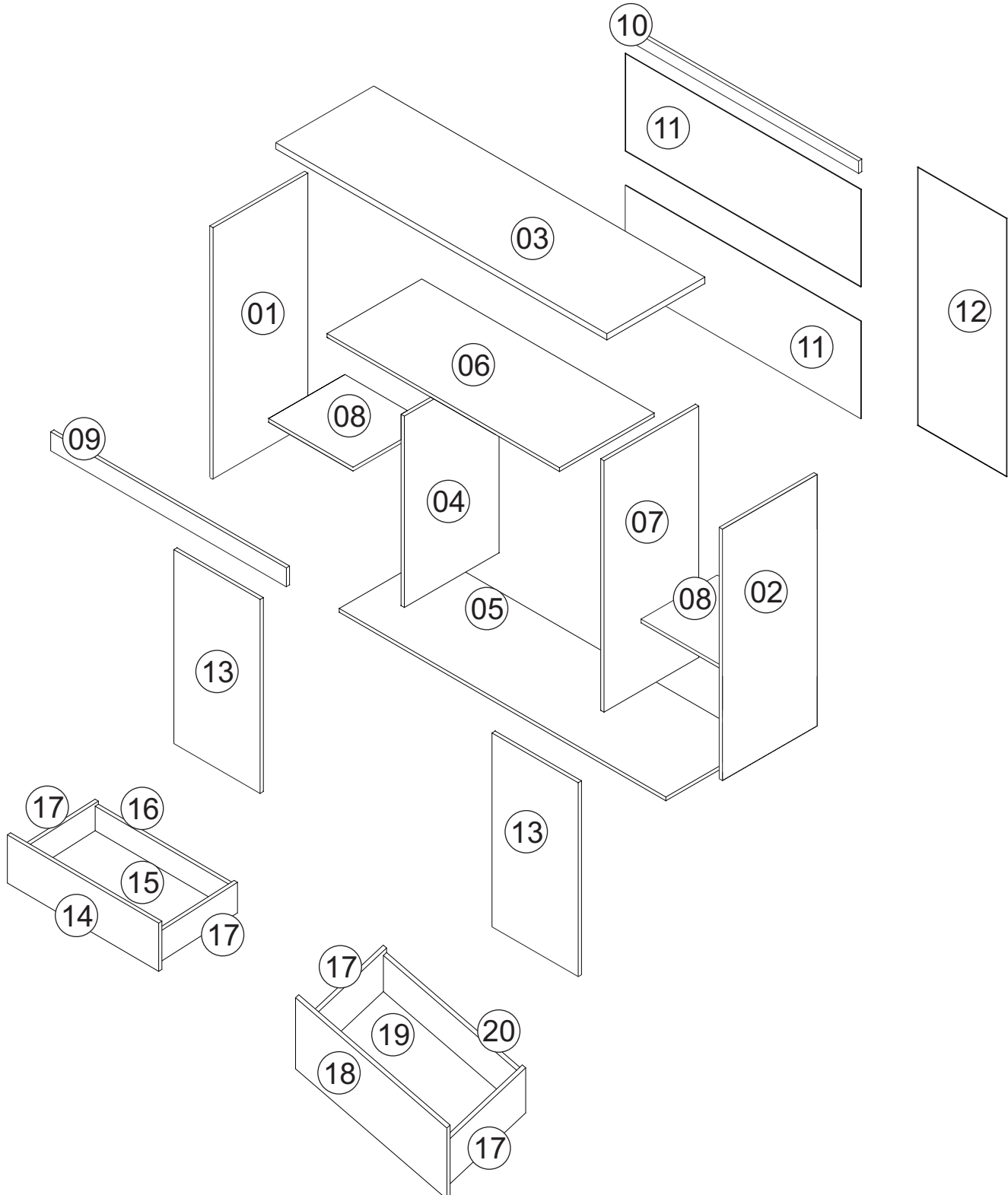

| Nº | CÓDIGO CODE ASSISTÊNCIA ATTENDANCE | NOME DA PEÇA/DESCRIPCIÓN PIEZAS/DESCRIPTION PARTS | MEDIDAS (mm) MEASURES (mm) | QTD. | NOGAL | HAVANA | TAUPE OFF WHITE | MARROCOS | FREIJO | CASTANHO |
|----|---|--|-------------------------------|------|--------|--------|--------------------|----------|--------|----------|
| 01 | CO008.18.00 | Lateral externa esquerda/Lateral izquierda/Left side | 1000x435x15 | 01 | 154167 | 103828 | 115129 | 188637 | 212717 | 265950 |
| 02 | CO008.17.00 | Lateral externa direita/Lateral derecha/Right side | 1000x435x15 | 01 | 154168 | 91909 | 115111 | 188637 | 212718 | 265951 |
| 03 | CO008.33.00 | Tampo/Tapa/Cover | 1520x460x25 | 01 | 176983 | 176847 | 176866 | 188615 | 212696 | 265929 |
| 04 | CO008.22.01 | Lateral interna/Lateral interna/Inner side | 761x435x15 | 01 | 167122 | 167117 | 167119 | 188635 | 212715 | 265948 |
| 05 | CO008.01.00 | Base Inferior/Base/Shelf | 1500x435x15 | 01 | 154145 | 89373 | 115133 | 183612 | 212693 | 265926 |
| 06 | CO008.04.00 | Base Sob gaveta/base cajón/ Base under drawer | 1067x435x15 | 01 | 154171 | 89334 | 115107 | 188641 | 212721 | 265954 |
| 07 | CO008.22.00 | Lateral interna/Lateral interna/Inner side | 1000x435x15 | 01 | 154166 | 89368 | 115130 | 188636 | 212716 | 265949 |
| 08 | CO008.02.00 | Base interna/Base/Shelf | 388x350x15 | 02 | 87466 | 87466 | 87466 | 87466 | 87466 | 87466 |
| 09 | CO008.12.00 | Ripa envoltorio/Envoltura de tablilla/Clapboard wrap | 1067x75x15 | 01 | 154169 | 89336 | 115109 | 188639 | 212719 | 265952 |
| 10 | CO008.28.00 | Ripa sustentação/Ripa sustentación /Slat support | 1067x50x15 | 01 | 87468 | 87468 | 87468 | 87468 | 87468 | 87468 |
| 11 | CO008.13.01 | Forro/Revés/botton | 1085x390x2,5 | 02 | 89375 | 89375 | 89375 | 89375 | 89375 | 89375 |
| 12 | CO008.13.00 | Forro/Revés/botton | 1027x408x2,5 | 01 | 89374 | 89374 | 89374 | 89374 | 89374 | 89374 |
| 13 | CO008.25.00 | Porta/Puerta/Door | 771x400x15 | 02 | 154147 | 89371 | 115131 | 188614 | 212695 | 265928 |
| 14 | CO008.14.00 | Frente de gaveta/ Frente del cajón/ Drawer front | 674x190x15 | 04 | 172694 | 172704 | 172712 | 188613 | 212694 | 265927 |
| 15 | CO008.34.00 | Forro de gaveta/Revés del cajón /botton | 626x355x2,5 | 04 | 87473 | 87473 | 87473 | 87473 | 87473 | 87473 |
| 16 | CO008.29.00 | Traseiro de gaveta/Cajón trasero/Drawer back | 616x100x12 | 04 | 89370 | 89370 | 89370 | 89370 | 89370 | 89370 |
| 17 | CO008.15.00 | Lateral de gaveta/ Lado del cajón/ Drawer side | 350x120x12 | 10 | 87470 | 87470 | 87470 | 87470 | 87470 | 87470 |
| 18 | CO008.14.01 | Frente de gaveta/ Frente del cajón/ Drawer front | 402x221x15 | 01 | 172699 | 172708 | 172716 | 188640 | 212720 | 265953 |
| 19 | CO008.34.02 | Forro de gaveta/Revés del cajón /botton | 350x355x2,5 | 01 | 251367 | 251367 | 251367 | 251367 | 251367 | 251367 |
| 20 | CO008.29.02 | Traseiro de gaveta/Cajón trasero/Drawer back | 340x100x12 | 01 | 251366 | 251366 | 251366 | 251366 | 251366 | 251366 |

Ferragens/Herrajes/Hardware

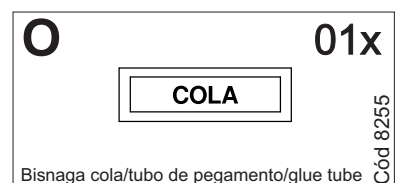
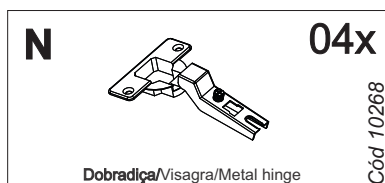
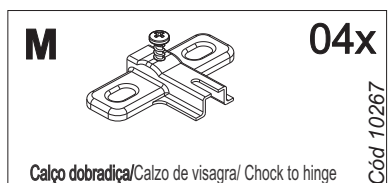
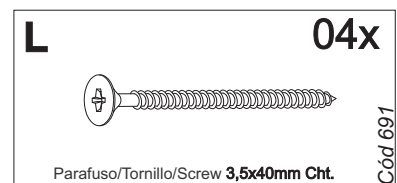
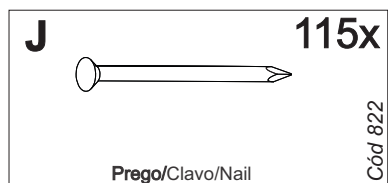
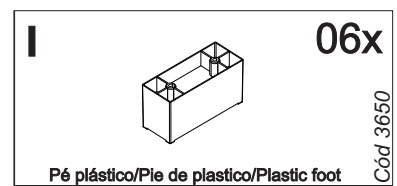
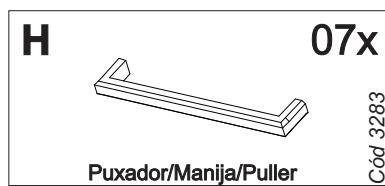
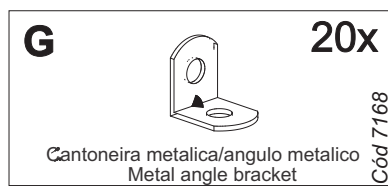
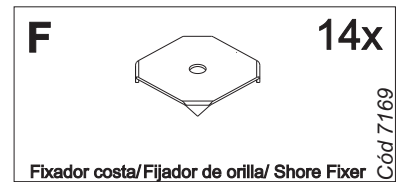
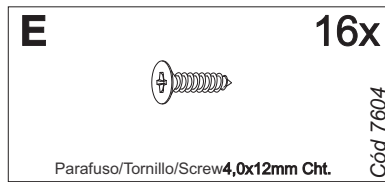
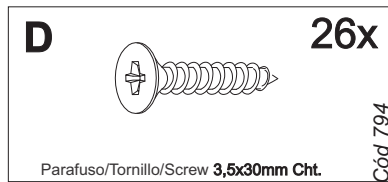
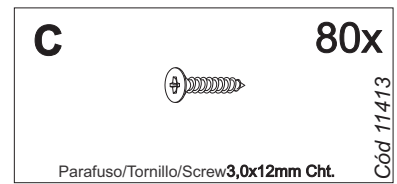
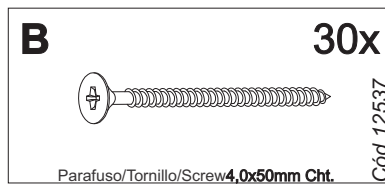
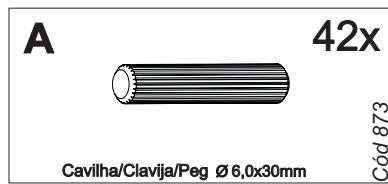

Medidas em mm
Measures in mm
Mesuras en mm

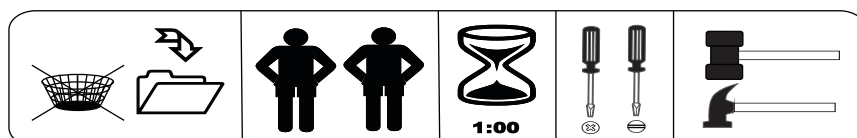
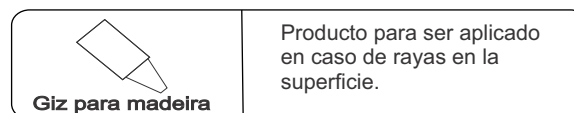
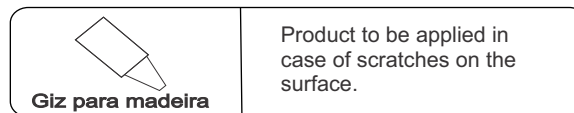
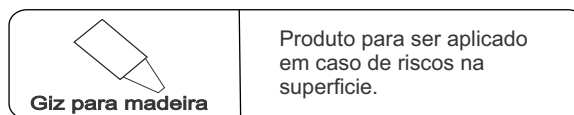

Pré-Montagem/Preparación Piezas/ Pre-assembly

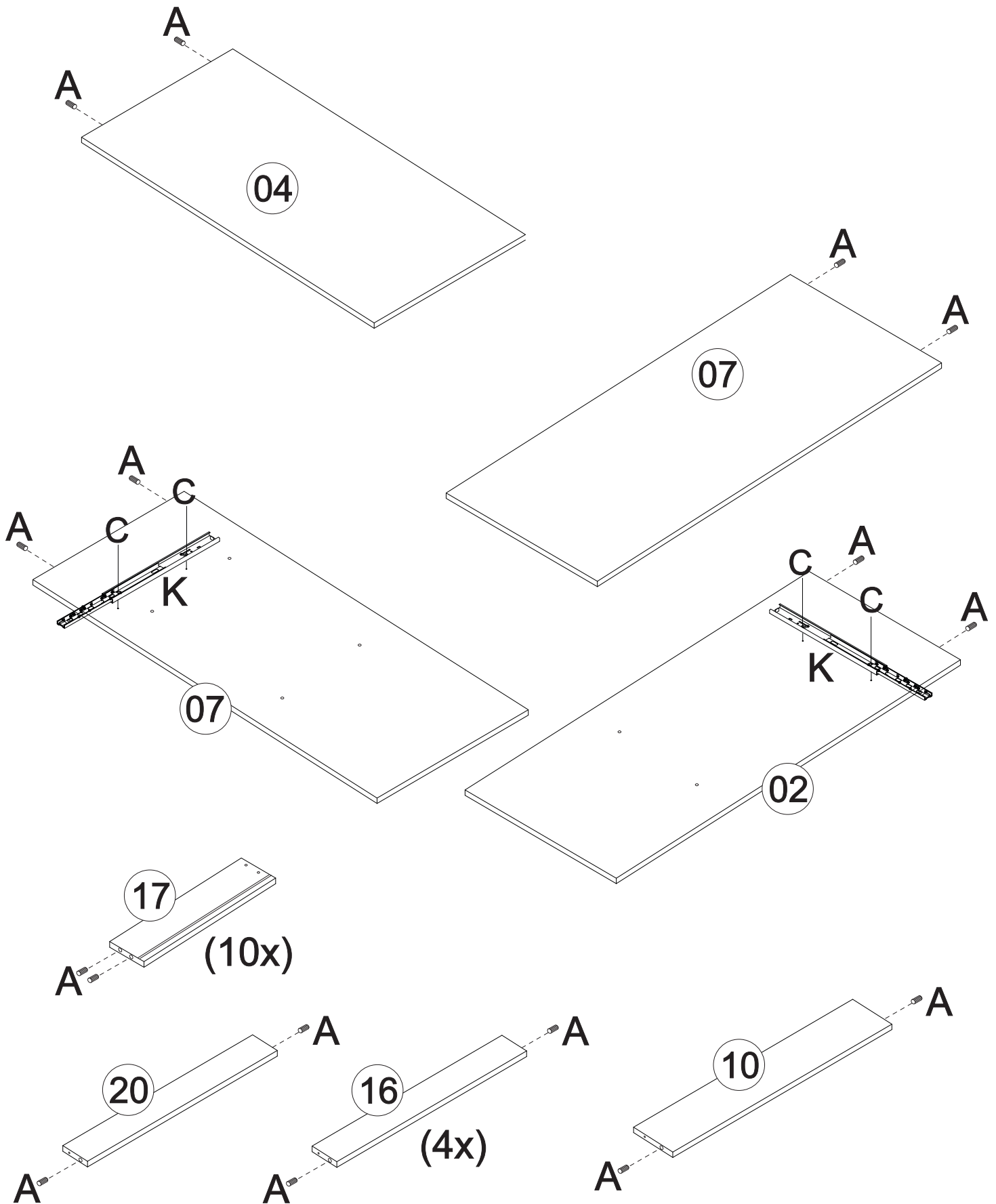

01 Montagem/Montaje/Assembly

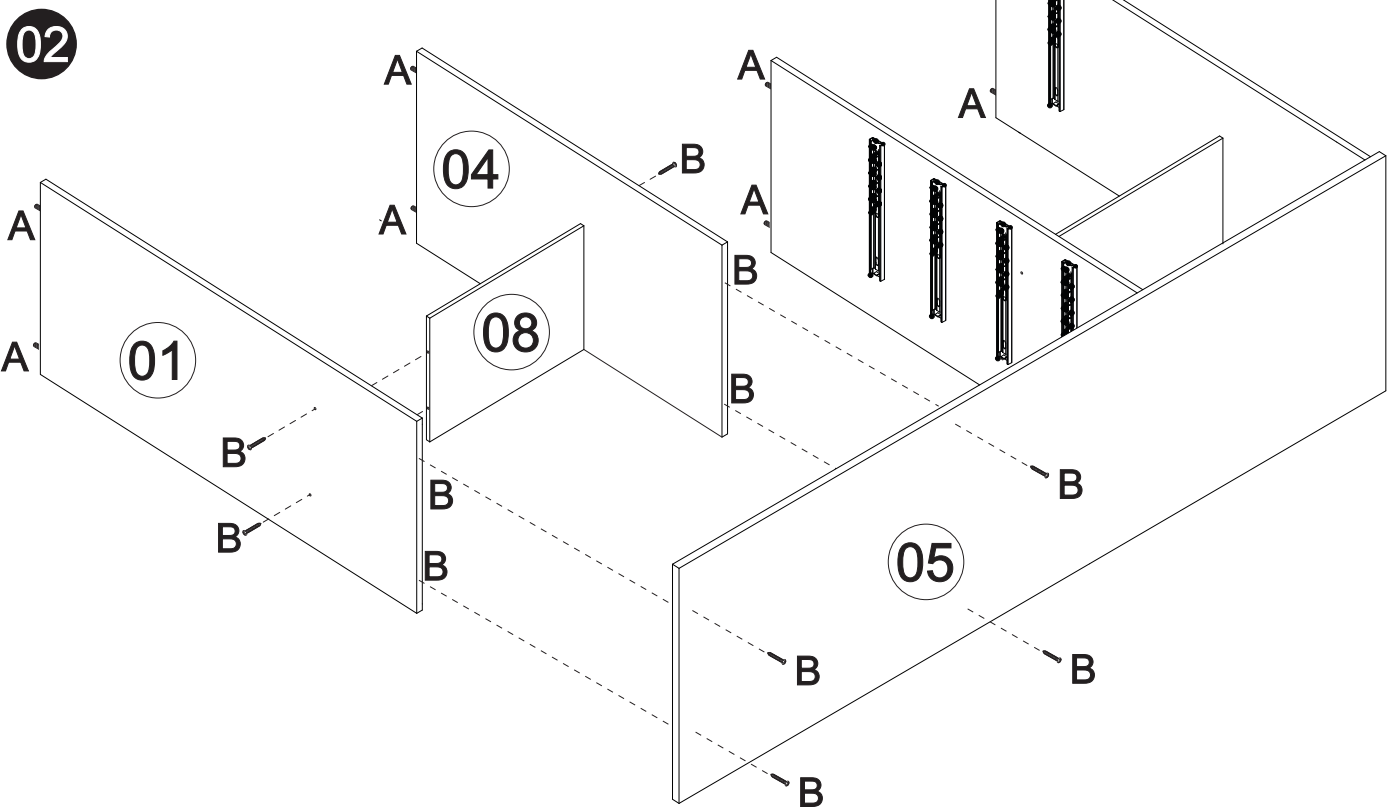
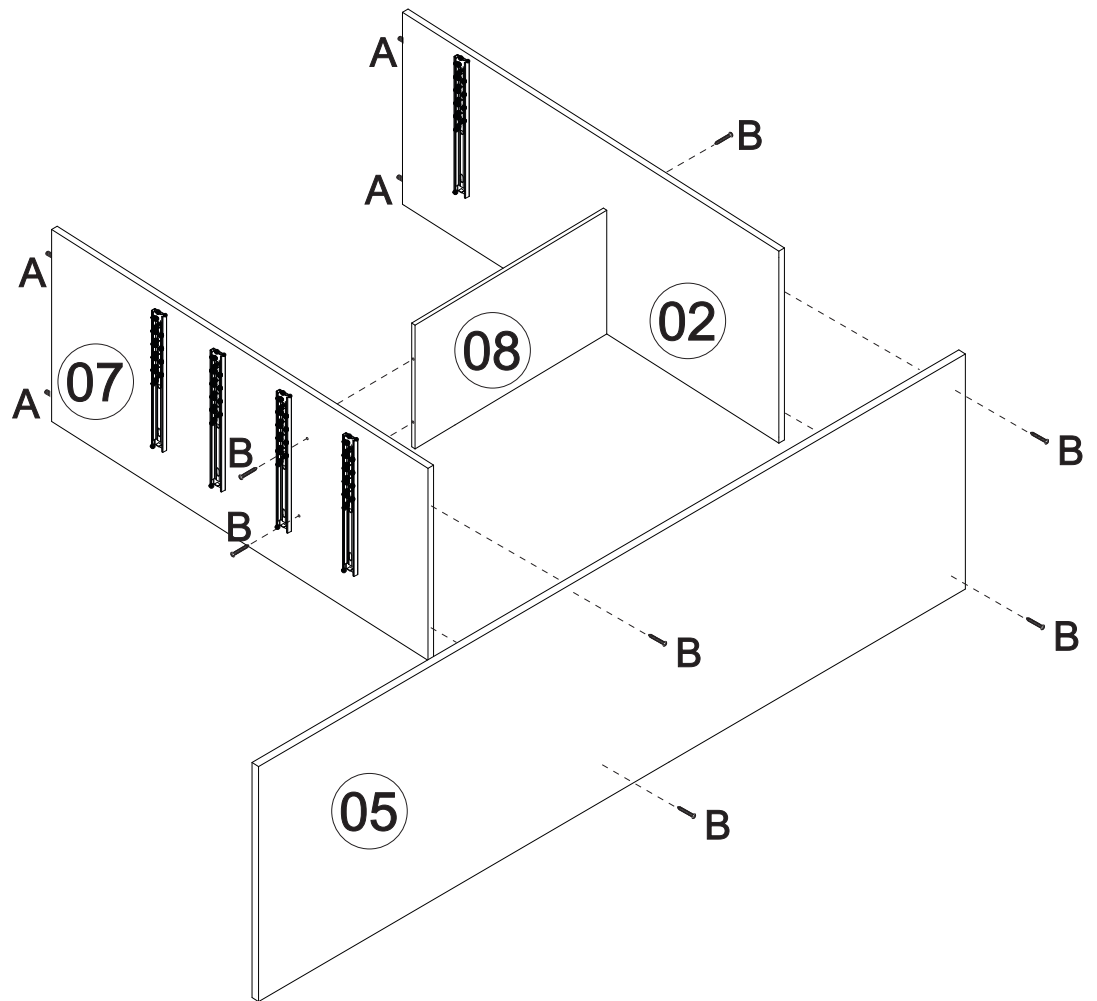

03

Montagem/Montaje/Assembly

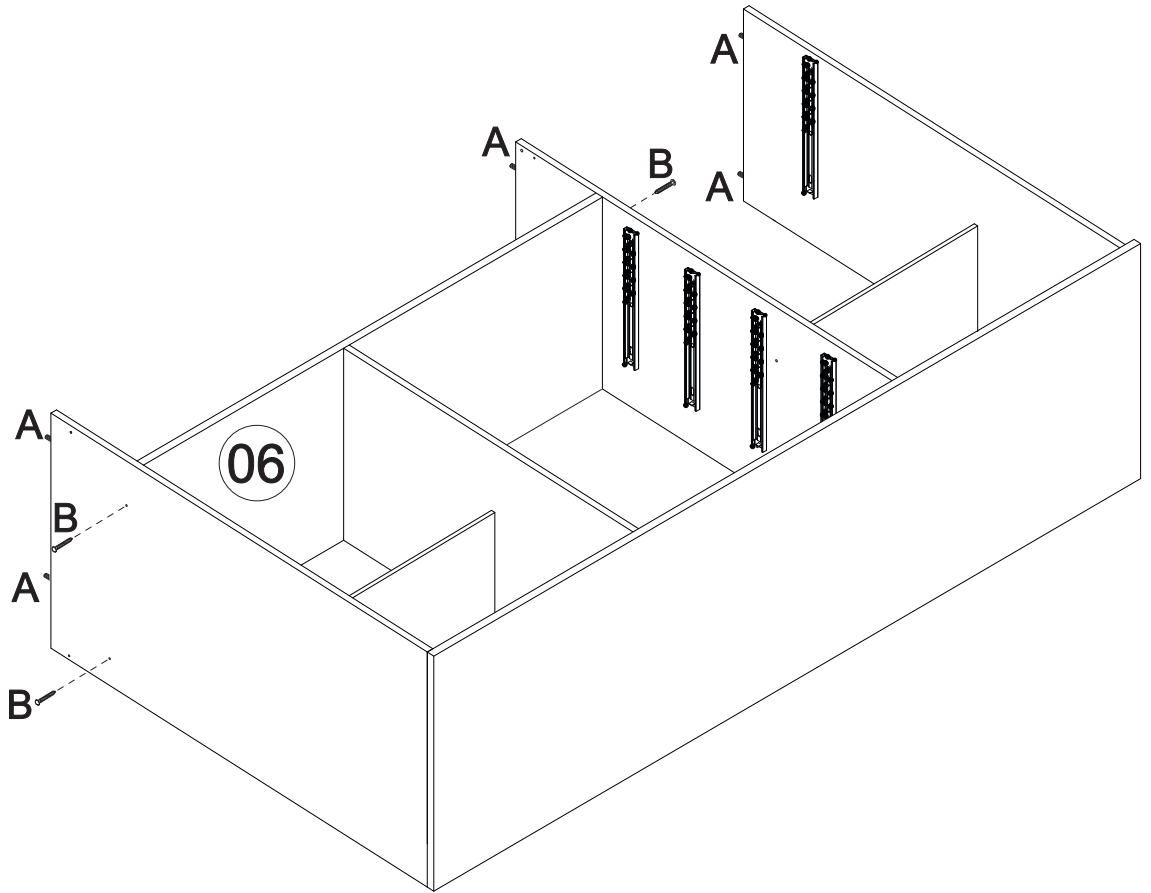

04

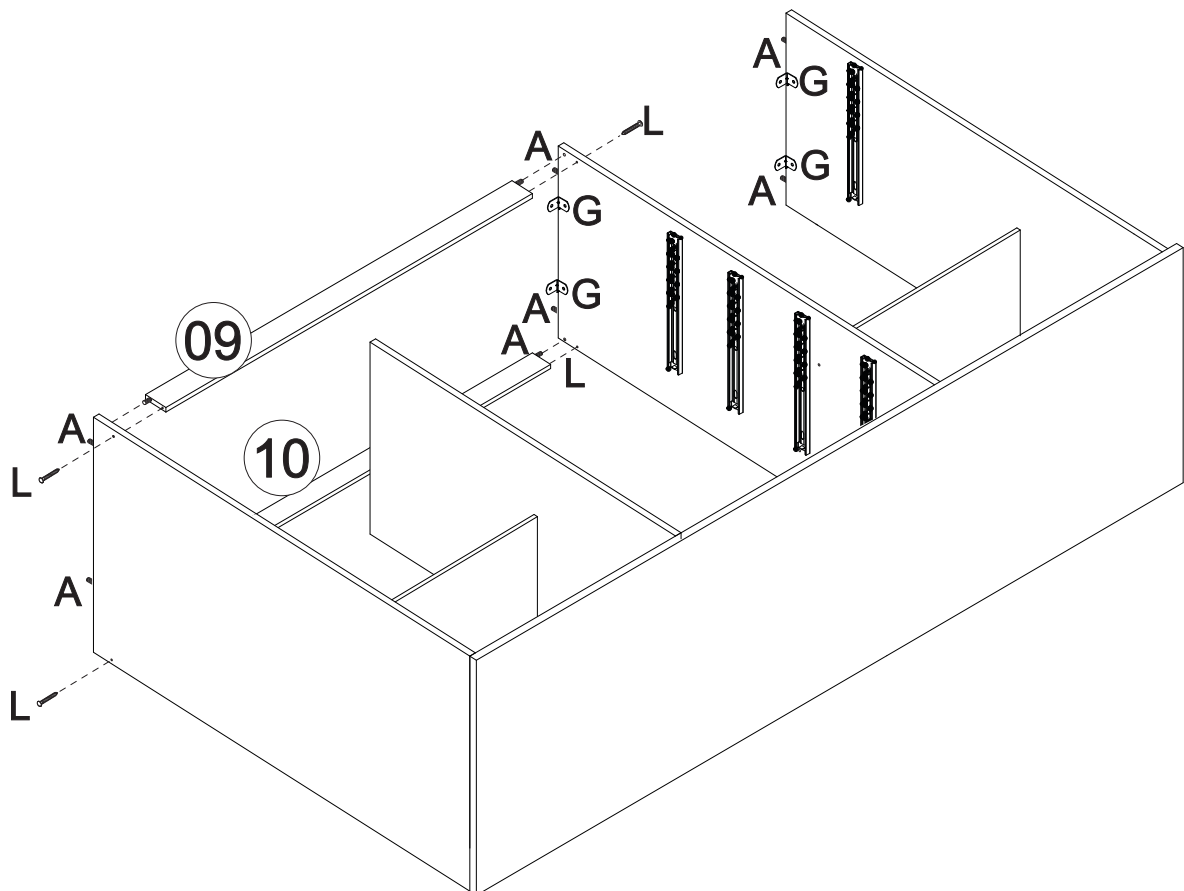

05 Montagem/Montaje/Assembly

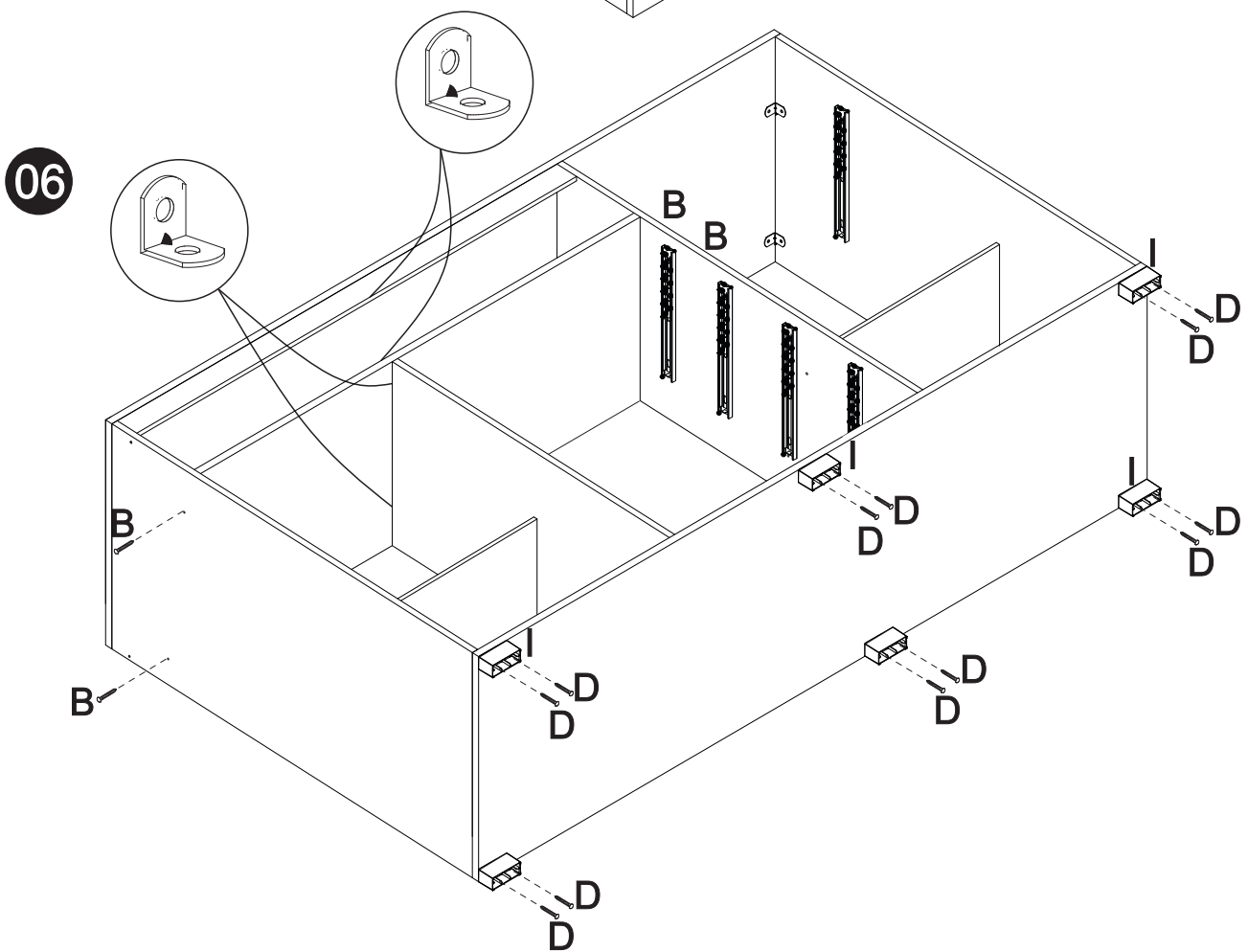
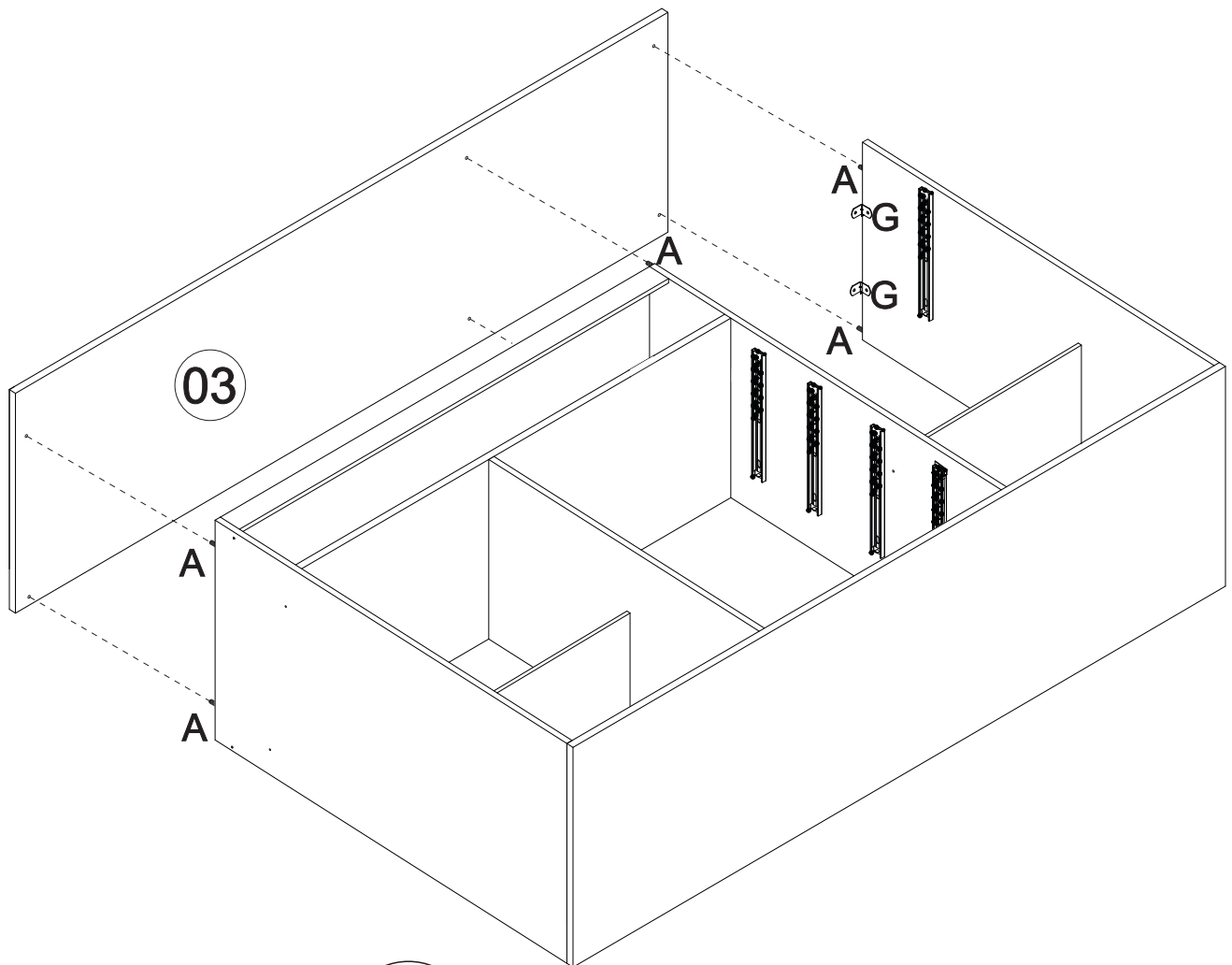

07 Montagem/Montaje/Assembly

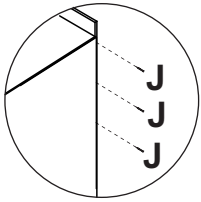

- *Colocar um prego (J) a cada 150mm
- *Colocar un clavo cada (J) 150mm
- *Place a nail every (J) 150mm

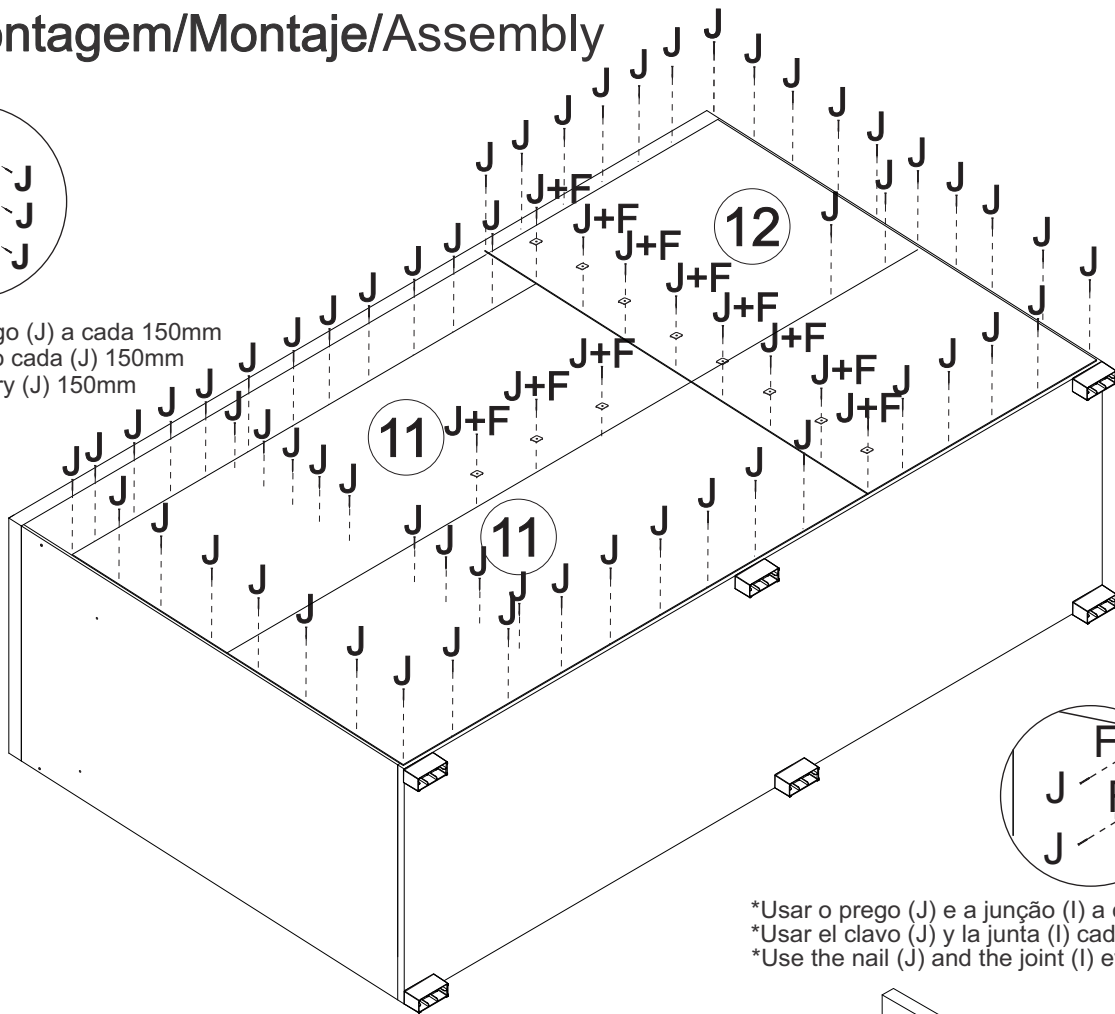

- *Usar o prego (J) e a junção (I) a cada 150mm
- *Usar el clavo (J) y la junta (I) cada 150mm
- *Use the nail (J) and the joint (I) every 150mm

08 Montagem/Montaje/Assembly

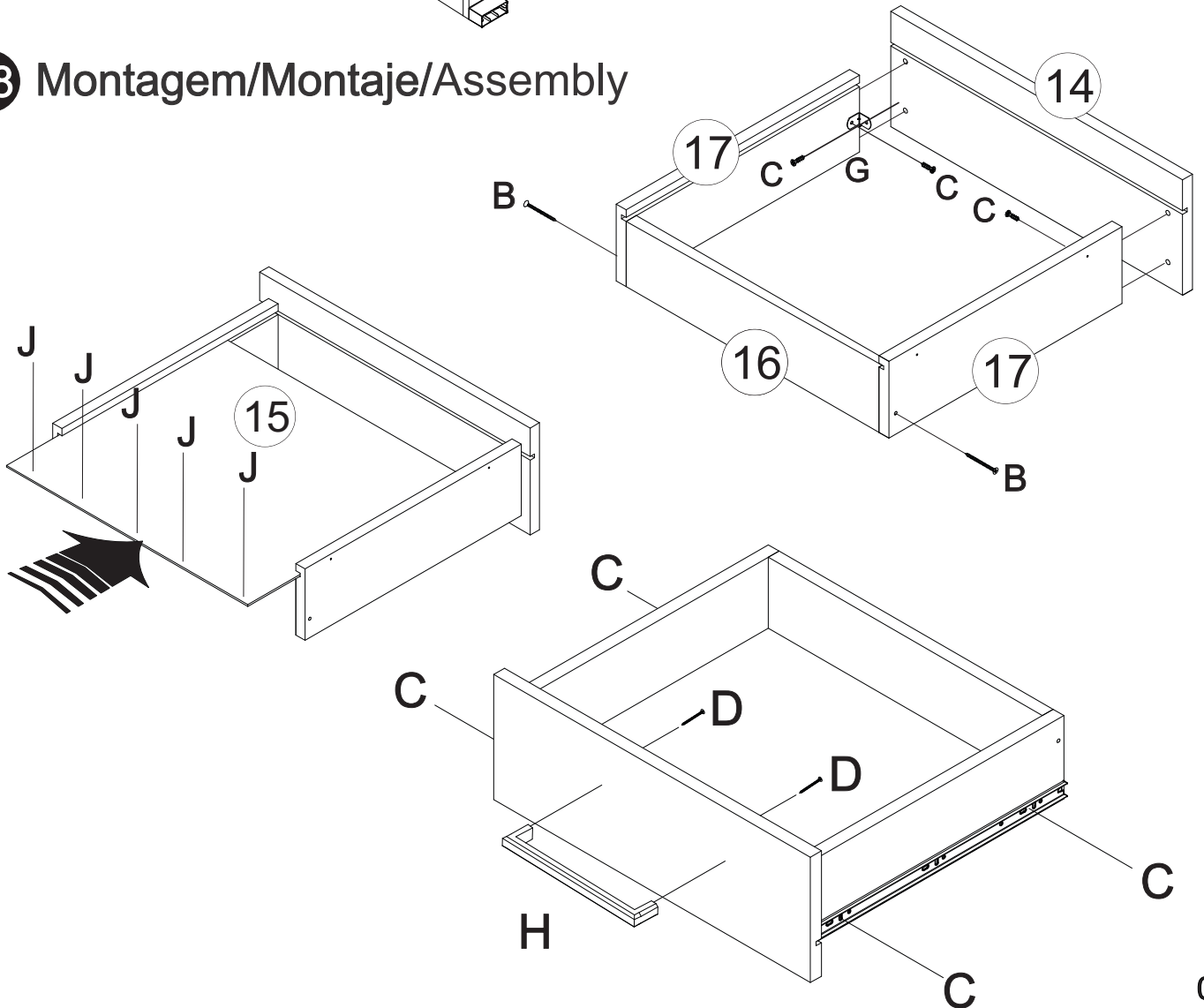

09 Montagem/Montaje/Assembly

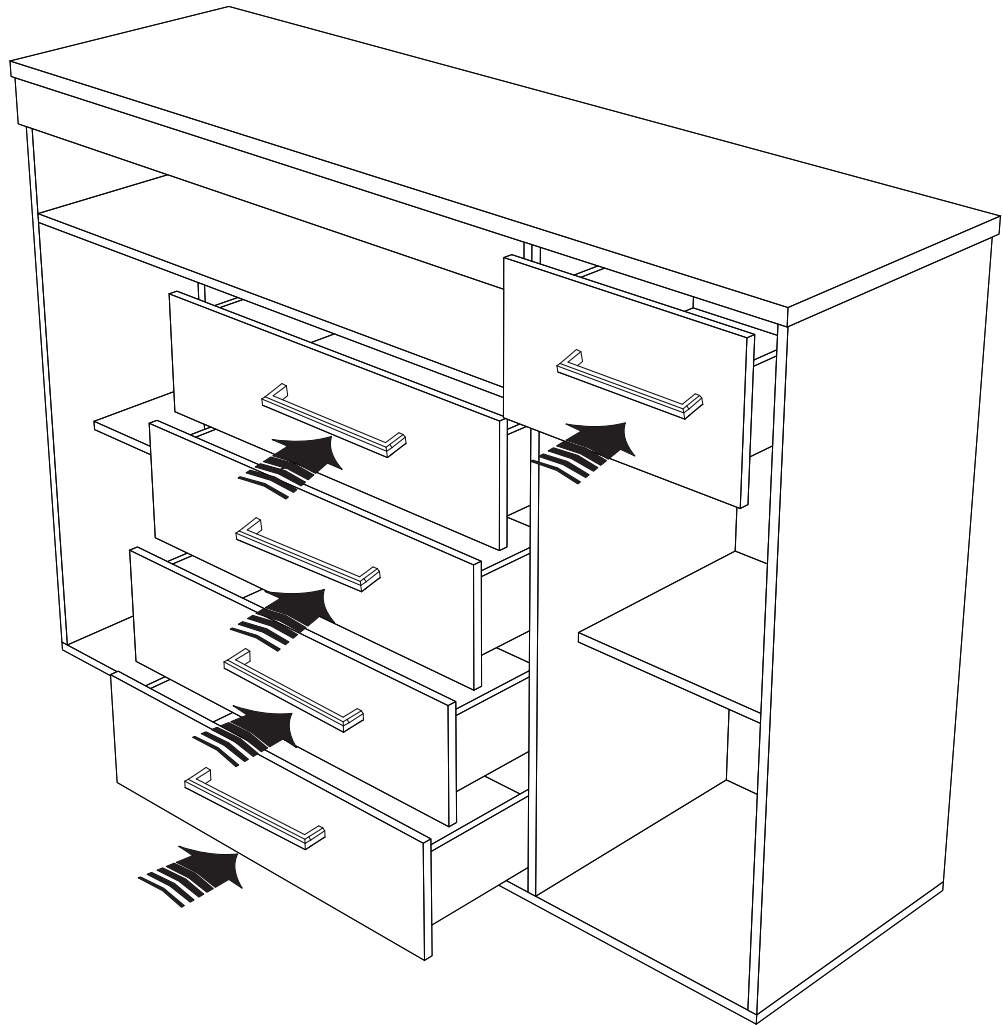

10

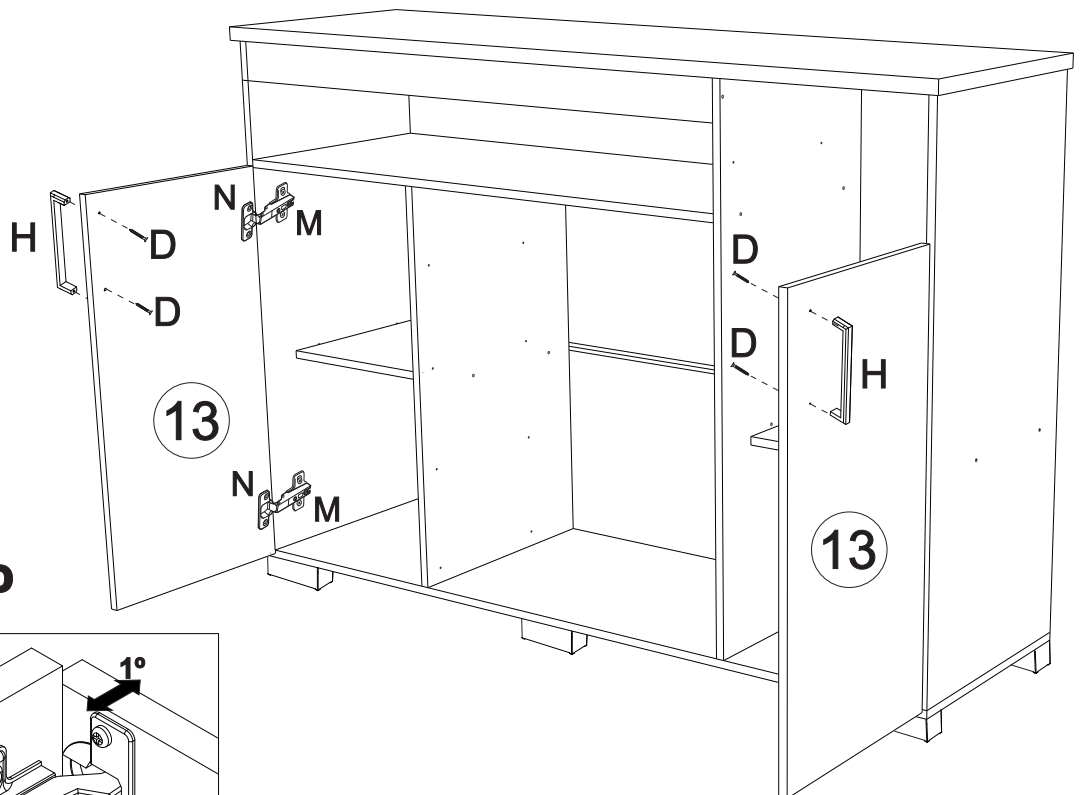
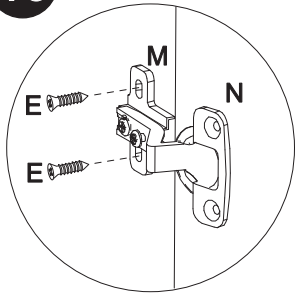

1°

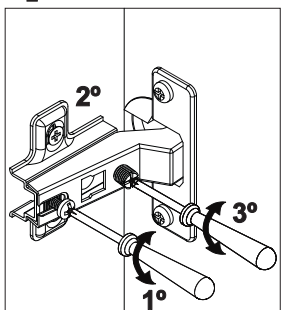

2°

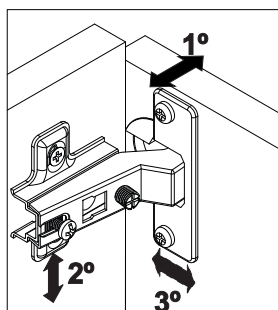

Montagem/Montaje/Assembly

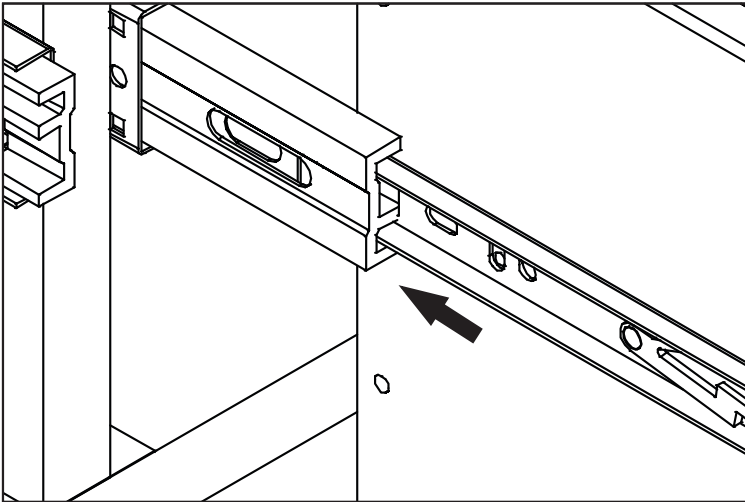

-Para retirar parte da corredeira e fixar nas laterais das gavetas é necessário movimentar o aplicador de plástico que encontra-se no verso da mesma.

-Para desmontar parte de la corredera y fijarla a los laterales de los cajones, es necesario desplazar el aplicador de plástico situado en la parte trasera de la corredera.

-To remove part of the slide and fix it to the sides of the drawers, it is necessary to move the plastic applicator located on the back of the slide.

Passo 1: Mover o aplicador para cima e segurar, ao mesmo tempo puxa a parte removível da corredeira. Segue exemplo:

Paso 1: Mueva el aplicador hacia arriba y sostenga, al mismo tiempo tire de la parte removible del deslizador. Aquí hay un ejemplo:

Step 1: Move the applicator upwards and hold, at the same time pull the removable part of the slider. Here's an example:

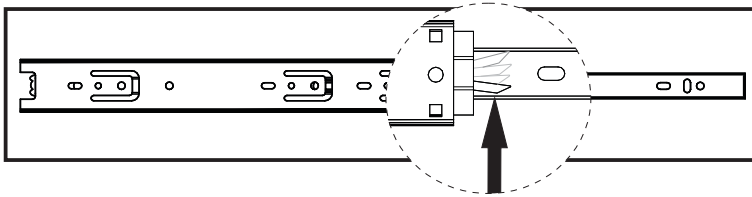

Passo 2: Após fixado nas gavetas e nas laterais do movel, encaixar as gavetas nas corredeiras fixas nas laterais empurando-a.

Paso 2: Después de fijar los cajones y los laterales del mueble, encajar los cajones en las correderas fijadas de los laterales empujándolos.

Step 2: After fixing the drawers and the sides of the furniture, fit the drawers in the fixed slides on the sides, pushing it

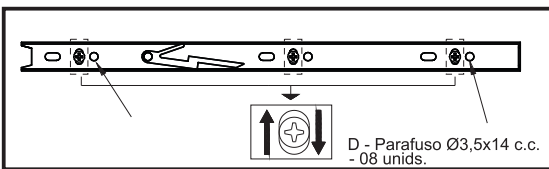

Espaço livre na vertical: Retire a gaveta, desparafuse a corredeira na lateral direita e esquerda da gaveta. Regule conforme a necessidade e parafuse novamente. Coloque novamente a gaveta no movel, caso a folga esteja correta favor retirar a novamente a gaveta e aplicar mais dois parafuso na corredeira, usando o furo fixo conforme desenho abaixo.

Espacio libre vertical: retire el cajón, desenrosque la corredera en el lado derecho e izquierdo del cajón. Ajuste según sea necesario y vuelva a atornillar. Vuelva a colocar el cajón en el mueble, si el espacio es correcto, retire el cajón nuevamente y aplique dos tornillos más a la corredera, usando el orificio fijo como se muestra en el dibujo a continuación.

Vertical free space: Remove the drawer, unscrew the slide on the right and left side of the drawer. Adjust as needed and screw again. Put the drawer back on the furniture, if the gap is correct, please remove the drawer again and apply two more screws in the slide, using the fixed hole as shown in the drawing below.

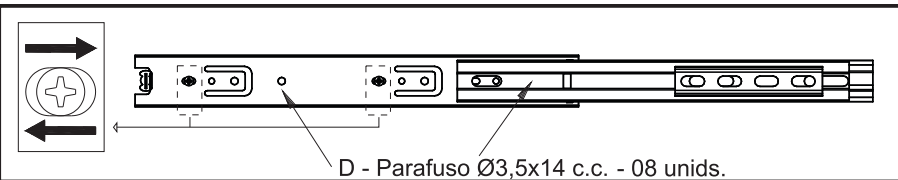

Espaço livre na Horizontal: Retire a gaveta, desparafuse a corredeira na lateral do movel. Regule conforme a necessidade e parafuse novamente. Coloque novamente a gaveta no movel, caso a folga esteja correta favor retirar a novamente a gaveta e aplicar mais dois parafuso na corredeira, usando o furo fixo conforme desenho.

Espacio libre horizontal: Retire el cajón, desenrosque la corredera en el costado del gabinete. Ajuste según sea necesario y vuelva a atornillar. Vuelva a colocar el cajón en el mueble, si el espacio es correcto, retire el cajón nuevamente y aplique dos tornillos más a la corredera, usando el orificio fijo como se muestra en el dibujo.

Horizontal free space: Remove the drawer, unscrew the slide on the side of the cabinet. Adjust as needed and screw again. Put the drawer back on the furniture, if the gap is correct, please remove the drawer again and apply two more screws to the slide, using the fixed hole as shown in the drawing.