

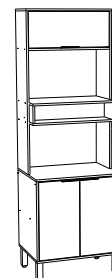

Rodovia SC-492 - Km 10 - B. Industrial
89905-000 - Bandeirante - SC
Fone: (49) 3622-4549
e-mail: mxmoveis@mxmoveis.com.br

Ref. TGL01

Torre quente 2 fornos
Cozinha/Cocina
GLORIA

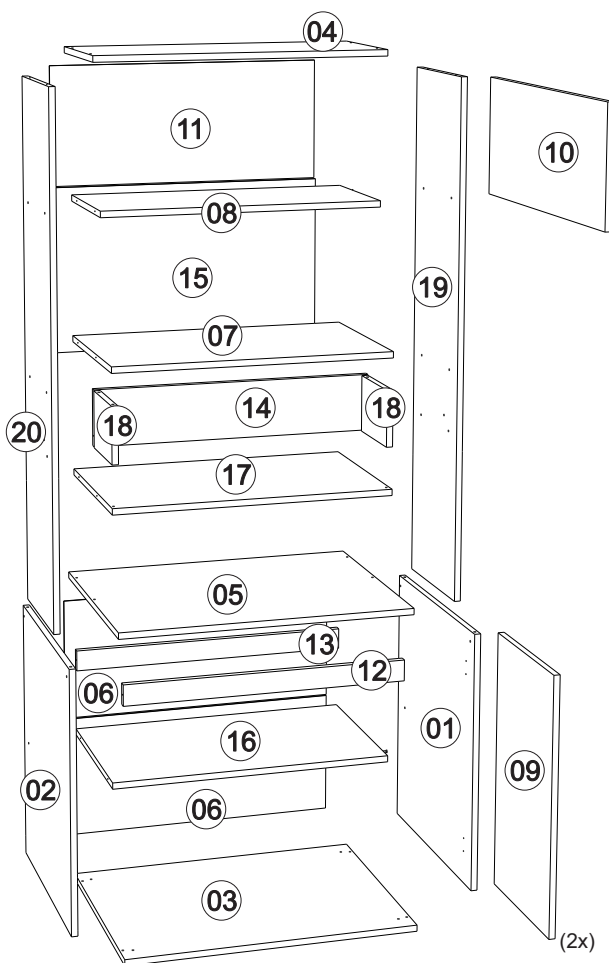

Nº	CÓDIGO ASSISTÊNCIA CODE ATTENDANCE	NOME DA PEÇA/DESCRIPCIÓN PIEZAS/DESCRIPTION PARTS	MEDIDAS (mm) MEASURES (mm)	QTD.	CASTANHO OFF WHITE	BRANCO NEVE BRANCO NEVE
01	TGL01.17.00	Lateral externa direita/Lateral derecha/Right side	625x516x15	01	263926	277580
02	TGL01.18.00	Lateral externa esquerda/Lateral izquierda/Left side	625x516x15	01	263928	277582
03	TGL01.01.00	Base Inferior/Base/Shelf	700x516x15	01	263920	277577
04	TGL01.05.00	Base superior/Base superior/Top base	700x300x15	01	263924	277579
05	TGL01.33.00	Tampo/Tapa/cover	700x516x15	01	263932	263932
06	TGL01.13.00	Forro/Revés/botton	686x300x2.5	02	260938	260938
07	TGL01.02.02	Base micro/Base	670x400x15	01	263923	263923
08	TGL01.01.01	Base inferior aéreo/Base inferior/Aerial lower base	670x300x15	01	263921	277578
09	TGL01.25.00	Porta balcão/Puerta/Balcony door	615x329x15	02	260953	277584
10	TGL01.25.01	Porta aéreo torre/Puerta/aerial door tower	662x277x15	01	264015	277585
11	TGL01.13.02	Forro aereo/Revés/Air lining	686x297x2.5	01	260940	260940
12	TGL01.28.00	Ripa sustentação frontal/Lama de soporte frontal/Front support slat	670x50x15	01	263930	277586
13	TGL01.28.01	Ripa sustentação tras/Listón de respaldo/Back support slat	670x50x15	01	260956	260956
14	TGL01.28.02	Ripa sustentação/listón de apoyo/Support slat	670x135x15	01	263931	263931
15	TGL01.13.01	Forro/Revés/botton	686x412x2.5	01	263918	277576
16	TGL01.02.00	Base interna/Base/Inner base	670x387x15	01	261612	261612
17	TGL01.02.01	Base interna/Base/Inner base	670x400x15	01	263922	263922
18	TGL01.38.00	Ripa de acabamento/Tabilla de acabado/Finishing clapboard	209x135x15	02	263925	263925
19	TGL01.17.01	Lateral externa direita/Lateral derecha/Right side	1265x300x15	01	263927	277581
20	TGL01.18.01	Lateral externa esquerda/Lateral izquierda/Left side	1265x300x15	01	263929	277583

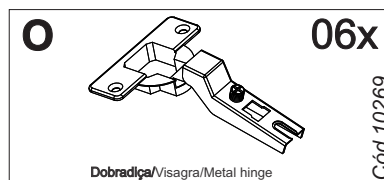
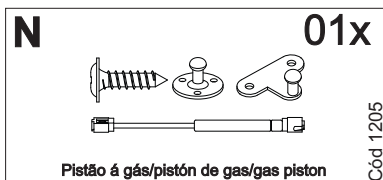
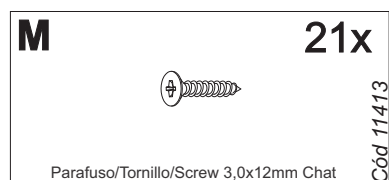
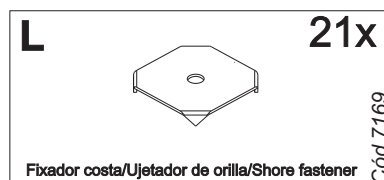
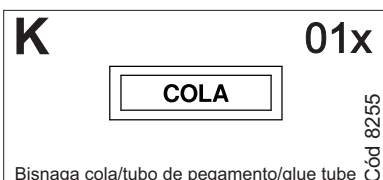
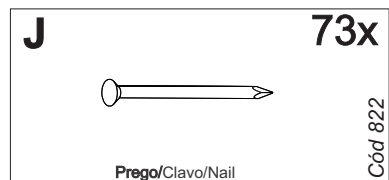
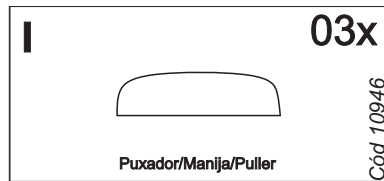
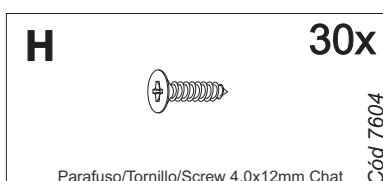
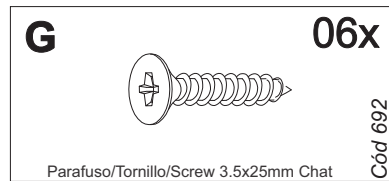
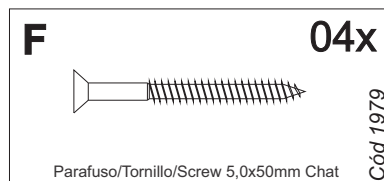
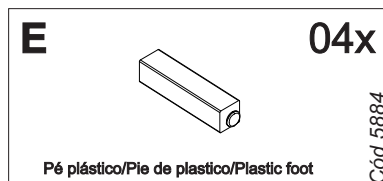
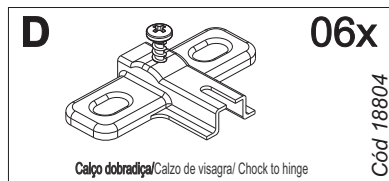
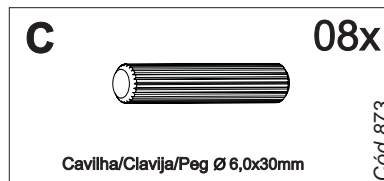
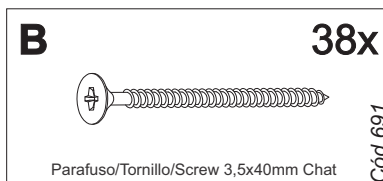

Ferragens/Herrajes/Hardware





Obs: a régua serve para medição da ferragem.
Nota: la regla se utiliza para medir el hardware.
Note: the ruler is used to measure the hardware.



Medidas em mm
Measures in mm
Meduras en mm

 *Usar os parafusos (G) para unir este módulo a outro.
Usar los tornillos (G) para unirse este módulo a otro.
*Use the screws (G) to connect this module to another. 

 Giz para madeira
Produto para ser aplicado em caso de riscos na superfície.

 Giz para madeira
Product to be applied in case of scratches on the surface.

 Giz para madeira
Producto para ser aplicado en caso de rayas en la superficie.

Limpeza/Limpieza

- ≠ Use um pano levemente umedecido com água, seguido de pano seco.
- ≠ Use solamente un paño húmedo con agua y después un paño seco.
- ≠ Nunca utilize produtos químicos ou abrasivos.
- ≠ No utilice productos químicos o abrasivos.

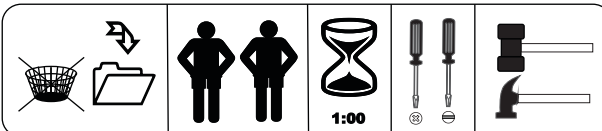

Pré-Montagem/Preparación Piezas

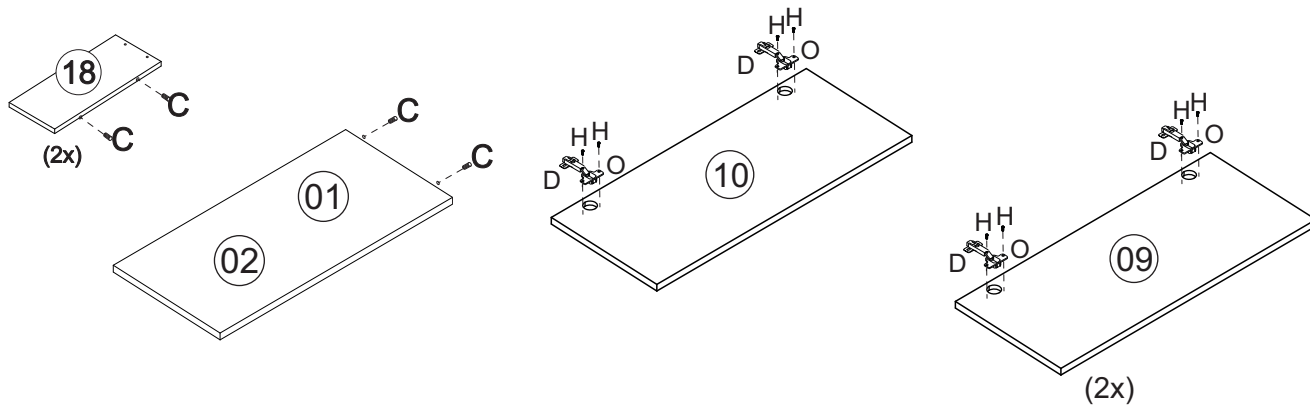

01 Montagem/Montaje

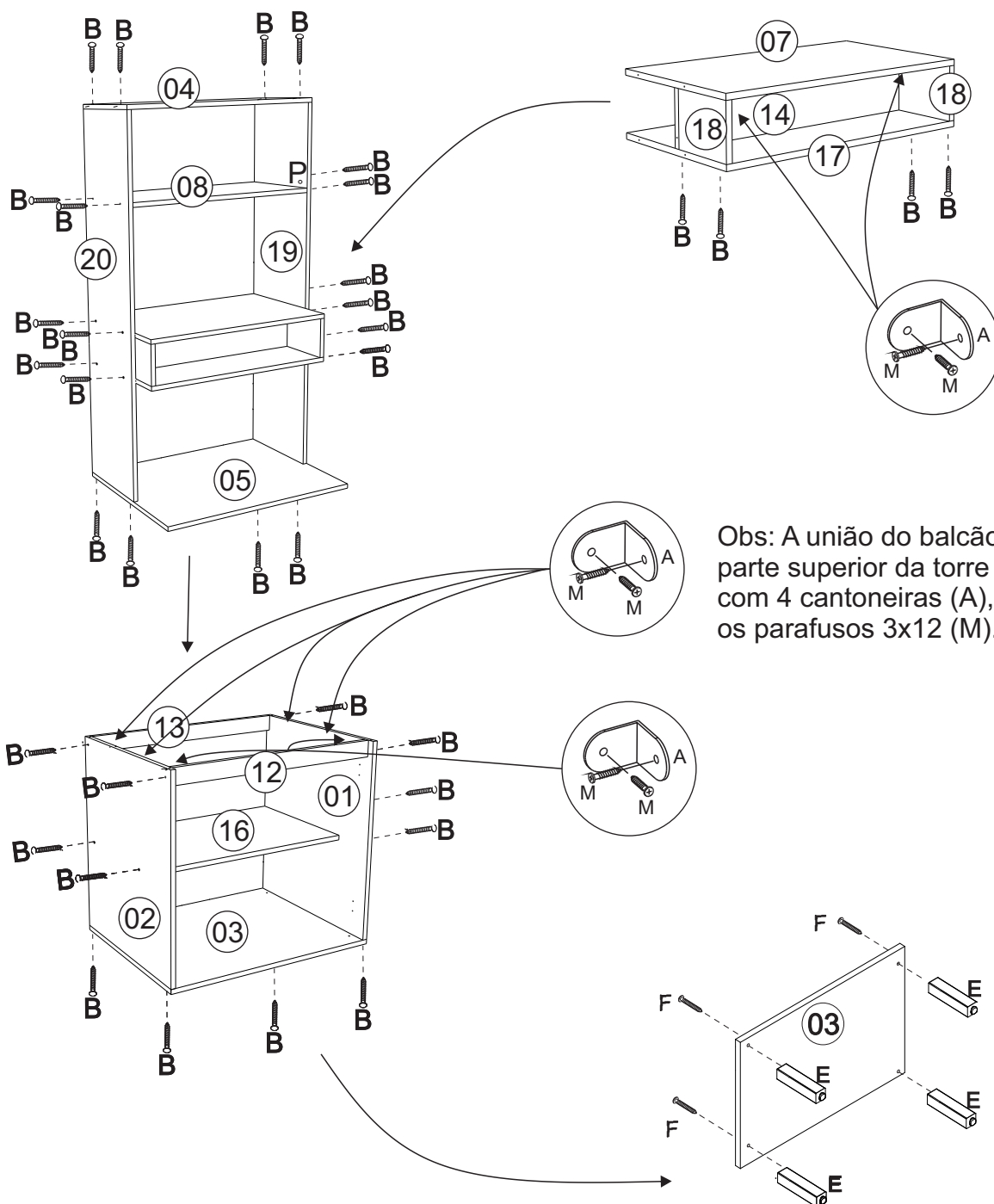

Obs: A união do balcão com a parte superior da torre se faz com 4 cantoneiras (A), e com os parafusos 3x12 (M).

02 Montagem/Montaje

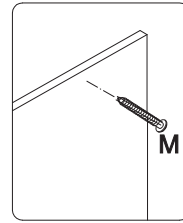
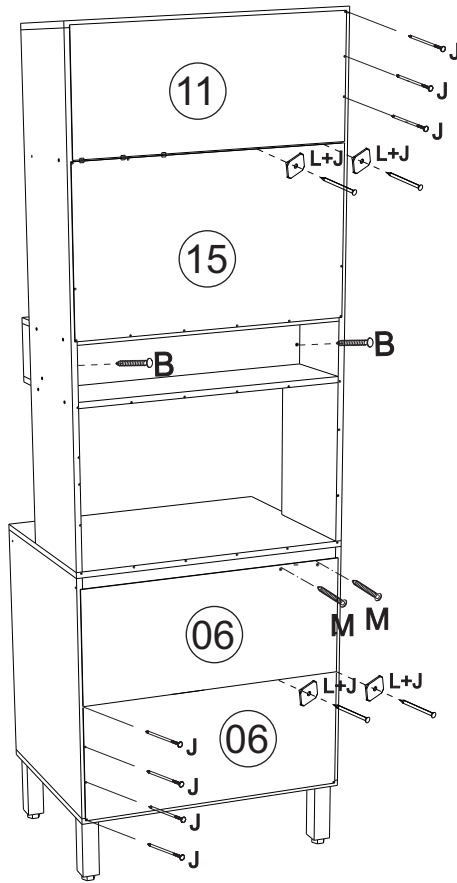

*Colocar um parafuso (M) a cada 100mm
 *Colocar un tornillo (M) cada 100mm
 *Place a screw (M) every 100mm

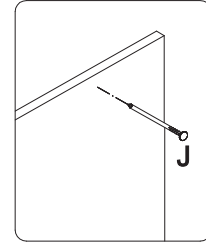

*Colocar um prego (J) a cada 100mm
 *Colocar un clavo (J) cada 100mm
 *Place a nail every (J) 100mm

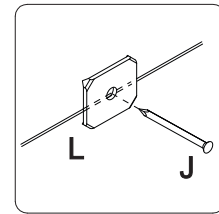

*Usar o prego (J) e a junção (L) a cada 100mm
 *Usar el clavo (J) y la junta (L) cada 100mm
 *Use the nail (J) and the joint (L) every 100mm

03 Montagem/Montaje

